

COLOR EXPERT TRAFALEȚI, ROLE ȘI ACCESORII

Pentru o mai bună și mai rapidă selecție din oferta generoasă, pe lângă imaginile și caracteristicile produselor, găsiți de asemenea pictograme care descriu comportarea articolului folosit și calitățile speciale ale acestuia. Respectivele simboluri se regăsesc și pe ambalajele produselor cu marca COLOR EXPERT.

I. Recomandarea pentru un anumit tip de vopsea (este valabil pentru pensule și role)



Pentru lacuri cu conținut de solvenți

Pentru lacuri pe bază de apă/ acrilice

Pentru baițuri/ protecție lemn

Pentru vopsele în dispersie, pe bază de latex și pt. fațade

2. Alte caracteristici de calitate

Culoarea pictogramei corespunde codului de culoare numit la I. (Pictogramele sunt protejate de legea drepturilor de autor)



Durabilitate foarte mare



Cantitate mare de vopsea aplicată



Extra fără scame



Extra fără stropire



Extra pentru suprafețe rugoase

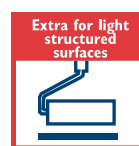

Extra pentru suprafețe ușor structurate



Extra finis foarte uniform



Extra curățire rapidă

3. Exemple de prezentare



4. Tipuri de pluș

În general sunt valabile următoarele:

- cu cât înălțimea firului este mai mare, cu atât finisul de suprafață este mai grosier, dar și cantitatea de vopsea preluată și randamentul sunt mai mari.
- Blana de miel și lâna asigură un finis de suprafață mai fin decât alte materiale cu aceeași lungime a firului.
- Plușurile țesute lasă mai puține scame decât plușurile tricotate și sunt mai ușor de curățat.
- Deoarece fabricile noastre sunt certificate ISO putem garanta respectarea greutateii date a plușului (g/m^2) astfel încât fiecare cumpărător să poată înțelege structurarea prețurilor noastre.

Role pentru suprafețe mari de la 18 cm lățime și diametru de 40 mm

Miez pentru inserare etrier

metoda de producție. "pt. vălțuire colțuri" = cusut
rest= "termofuzionat"= sudat termoplastic sau lipit

Cod art. | Dimensiuni | UV | APG | Descriere

Miez \varnothing 40 mm, pentru mâner alunecare 8mm

Lână (Velur), țesut

84 26 18 20	18 cm	6	B	
84 26 25 20	25 cm	6	B	
84 27 18 20	18 cm	1	B	
84 27 25 20	25 cm	1	B	

1. Fără fig.:
Lungime fir: 4 mm
g/m²: min. 730
amestec velur-polieszter

Lungime fir: 4 mm
g/m² min.: 770



1



Lacuri cu conținut de solvenți

Poliester, țesut

84 34 18 34	18 cm	5	B	
-------------	-------	---	---	--

2. Lungime fir: 4 mm
g/m² min.: 550
Fir continuu stabilizat



2



Lacuri pe bază de apă/ acrilice

Poliacril, țesut

84 31 18 20	18 cm	1	B	
84 31 25 20	25 cm	1	B	
84 31 45 20	45 cm	1	B	com.specială

3. Lungime fir: 7 mm,
g/m²: min. 640.
Fir continuu stabilizat

Miez: 47 mm



3



Lacuri pe bază de apă/ acrilice

Poliamid, țesut

84 66 18 05	18 cm	6	B	
84 66 23 05	25 cm	6	B	

4. Lungime fir: 12 mm
g/m² min.: 700



4



Vopsele în dispersie, pe bază de latex și pt. fațade

Poliamid, țesut

84 30 19 20	18 cm	5	B	com.specială
84 30 26 20	25 cm	5	B	com.specială

1. Lungime fir: 13 mm
g/m² min.: 930
ideal pentru vopsele
epoxidice, acoperiri
din două
componente, sigilări



1



Vopsele în dispersie, pe bază de latex și pt. fațade

84 29 18 34	18 cm	5	B	
-------------	-------	---	---	--

2. Lungime fir: 12 mm
g/m² min.: 860
Ideal pentru vopsele
dense



2



Vopsele în dispersie, pe bază de latex și pt. fațade

Miez Ø 47 mm, pentru mâner alunecare 8mm

Poliacril, țesut

84 41 25 20	25 cm	5	B	
-------------	-------	---	---	--

3. Lungime fir: 8 mm,
g/m²: min. 700



3



Lacuri pe bază de apă/ acrilice

Microfibră, țesut

84 55 18 20	18 cm	5	B	
84 55 25 20	25 cm	5	B	

4. Lungime fir: 9 mm
g/m² min.: 750
Fir continuu fixat



4



Baițuri/ protecție lemn

Poliester, tricotat sau țesut

84 15 18 05	18 cm	5	B	com.specială
84 15 25 05	25 cm	5	B	

5. Lungime fir: 18 mm
g/m² min.: 800
vălțuire colțuri



5



Vopsele în dispersie, pe bază de latex și pt. fațade

Cod art. | Dimensiuni | UV | APG | Descriere

Poliester, țesut

84 42 18 10	18 cm	5	B	com.specială
84 42 25 10	25 cm	5	B	

1. Lungime fir: 13 mm
g/m² min.: 820
țesut
ideal pentru vopsele
dense,
adezivi și
vopsele compacte

BASIS
QUALITY

1



Vopsele în dispersie, pe bază de latex și pt. fațade

Microfibră, țesut

84 54 25 20	25 cm	5	B	
-------------	-------	---	---	--

2. Lungime fir: 7 mm
g/m² min.: 670
ideal pentru grunduire,
dispersii
dense și latex

TOP
QUALITY

Extra
high capacity

Extra
lint free

Extra
easy cleaning

2



Vopsele în dispersie, pe bază de latex și pt. fațade

Poliacril, tricotat sau țesut

84 52 18 05	18 cm	5	B	
84 52 25 05	25 cm	5	B	

3. Lungime fir: 18 mm
g/m² min.: 1000
tricotat
vălțuire colțuri

PROFI
QUALITY

Extra
easy cleaning

3



Vopsele în dispersie, pe bază de latex și pt. fațade

84 52 19 10	18 cm	5	B	com.specială
84 52 26 10	25 cm	5	B	

4. Lungime fir: 18 mm
g/m² min.: 1000
țesut,
vălțuire colțuri

PROFI
QUALITY

Extra
long life

Extra
easy cleaning

4



Vopsele în dispersie, pe bază de latex și pt. fațade

Poliamid, țesut

84 64 18 20	18 cm	5	B	com.specială
84 64 25 20	25 cm	5	B	

5. Lungime fir: 20 mm
g/m² min.: 1150

TOP
QUALITY

Extra
long life

Extra
high capacity

Extra
easy cleaning

5



Vopsele în dispersie, pe bază de latex și pt. fațade

Cod art.	Dimensiuni	UV	APG	Descriere
84 16 25 20	25 cm	5	B	<p>1. Lungime fir: 13 mm g/m² min.: 940 ideal pentru vopsele dense, Rollputz</p>

TOP
QUALITY



1



Vopsele în dispersie, pe bază de latex și pt. fațade

Lână, țesut

84 47 18 01	18 cm	I	B	<p>2. Lungime fir: 22 mm g/m² min.: 1140 marginii exterioare tăiate</p>
84 47 25 05	25 cm	I	B	

TOP
QUALITY



2



Vopsele în dispersie, pe bază de latex și pt. fațade

Miez \varnothing 58 mm, pentru mâner alunecare 8mm

Poliester, tricatat

84 11 18 05	20 cm	5	B	<p>3. Lungime fir: 21 mm g/m² min.: 930 căptușit, pt. vălțuire colțuri</p>
84 11 25 05	27 cm	5	B	

BASIS
QUALITY



3



Vopsele în dispersie, pe bază de latex și pt. fațade

Microfibră, țesut

84 58 27 34	25 cm	5	B	<p>4. Lungime fir: 15 mm g/m² min.: 1000 ideal pentru grunduiri și impregnări</p>
-------------	-------	---	---	--

TOP
QUALITY



4



Vopsele în dispersie, pe bază de latex și pt. fațade

1.



13

Poliacril, tricotat sau țesut

84 53 18 05	20 cm	5	B	
84 53 25 05	27 cm	5	B	

1. Lungime fir: 18 mm
g/m² min.: 1000
tricotat
căptușit, pt. vâlțuire colțuri



1



Vopsele în dispersie, pe bază de latex și pt. fațade

84 53 19 10	20 cm	5	B	com.specială
84 53 26 10	27 cm	5	B	com.specială

2. Lungime fir: 18 mm
g/m² min.: 1000
țesut
căptușit, pt. vâlțuire colțuri



2

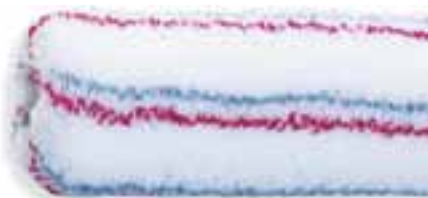

Vopsele în dispersie, pe bază de latex și pt. fațade

Poliamid, țesut

84 32 18 20	18 cm	5	B	
84 32 25 20	25 cm	5	B	

3. Lungime fir: 12 mm
g/m² min.: 860
condiționat pt. vâlțuire
colțuri,
ideal pentru vopsele
dense, Rollputz



3



Vopsele în dispersie, pe bază de latex și pt. fațade

84 62 18 20	20 cm	5	B	
84 62 25 20	27 cm	5	B	

4. Lungime fir: 20 mm
g/m² min.: 1150
căptușit, pt. vâlțuire
colțuri



4



Vopsele în dispersie, pe bază de latex și pt. fațade

Miez \varnothing 60 mm , pentru mâner alunecare 8mm

Poliamid, țesut

84 28 25 20	25 cm	5	B
-------------	-------	---	---

1. Lungime fir: 21 mm
g/m² min.: 1350
condiționat pt. vălțuire
colțuri, fir continuu,
prelucrat special pentru a
nu lăsa scame



1



Vopsele în dispersie, pe bază de latex și pt. fațade

Miez \varnothing 69 mm , pentru mâner alunecare 8mm

Poliacril, tricotat

84 51 18 05	20 cm	6	B
84 51 25 05	27 cm	6	B

2. Lungime fir: 18 mm
g/m² min.: 1000
căptușit, pt. vălțuire colțuri



2



Vopsele în dispersie, pe bază de latex și pt. fațade

Poliamid, țesut

84 63 25 20	27 cm	5	B
-------------	-------	---	---

3. Lungime fir: 20 mm
g/m² min.: 1150
căptușit, pt. vălțuire colțuri



3



Vopsele în dispersie, pe bază de latex și pt. fațade

84 35 25 20	27 cm	5	B
-------------	-------	---	---

4. Lungime fir: 21 mm
g/m² min.: 1350
căptușit, pt. vălțuire
colțuri, fir continuu,
prelucrat special pentru
a nu lăsa scame





4



Vopsele în dispersie, pe bază de latex și pt. fațade





Trafaleți și seturi complete, miez de la 40 mm la 58 mm

Lână (Velur), țesut

85 86 15 05	15 cm	5	B		1. Mieș: 40 mm Lungime fir: 4 mm g/m ² min.: 700 etrier fix pentru etrier: 6mm	 		1

Lacuri cu conținut de solvenți

Poliester, țesut



84 75 15 01	15 cm	5	B	com.specială	2. Mieș: 40 mm Lungime fir: 6 mm g/m ² min.: 560 etrier fix pentru etrier: 6mm	  		2

Lacuri pe bază de apă/ acrilice

Poliester, tricotat

85 90 19 10	18 cm	10	C		3. Mieș: 40 mm Lungime fir: 18 mm g/m ² min.: 570 etrier fix pentru etrier: 6mm set cu grătar plastic 18x32 cm			3
85 90 20 27	18 cm	10	C					
85 90 23 10	23 cm	10	C					

Vopsele în dispersie, pe bază de latex și pt. fațade

85 92 23 99	23 cm	8	C		4. Mieș: 40 mm Lungime fir: 18 mm g/m ² min.: 570 etrier detașabil pentru etrier: 6mm set cu tavă plastic 26x32 cm			4

Vopsele în dispersie, pe bază de latex și pt. fațade

86 83 65 01	23 cm	I	B	com.specială	5. Trafalet cu pompă cu sistem de prelungire și aspirare, rolă alimentată prin interior, rezervor de vopsea în mână, cantitate de umplere 520 ml Rolă: mieș 40 mm Lungime fir: 12 mm			5 6
86 83 99 99	23 cm	I	B	com.specială				

Vopsele în dispersie, pe bază de latex și pt. fațade

Poliacril, tricotat

84 98 75 99	27 cm	I	B
-------------	-------	---	---

- 1. Trafalet EXTRA REACH,**
Miez 58 mm
Lungime fir: 18mm
g/m² min.: 1000,
pt. vâlțuire colțuri
etrier telescopic cu mâner
"soft-grip" cu mecanism
de extindere cu 2 trepte
Lungime 44 – 90cm

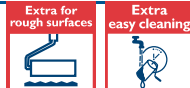

1



Vopsele în dispersie, pe bază de latex și pt. fațade

**Role pentru suprafețe mici, miez 15/16 mm și 30 mm,
Pentru etrier inserat de 6 mm**

Role de lăcuire (role de spumă și role cu o lungime a firului de până la 8 mm)

Miez de 15/ 16 mm

Polyether, diametru exterior 35 mm, structură "fină"

86 70 05 10	1x5 cm	20	B
86 70 11 10	1x11 cm	10	B
86 70 16 10	1x16 cm	10	B

- 2. Capete drepte pe ambele părți,**
ambalate individual



2



Lacuri cu conținut de solvenți

86 70 30 20	2x5 cm	10	B
86 70 31 01	2x7 cm	10	B
86 70 71 01	2x11 cm	10	B
86 70 76 20	2x16 cm	10	B
			com.specială
86 70 50 99	10x5 cm	1	B
86 70 40 99	10x11 cm	5	B
			com.specială

- 3. capete drepte**
blister 2 buc



3



Lacuri cu conținut de solvenți

Spumă poliesterică, diametru exterior 35 mm structură "superfină"

86 74 11 10	1x11 cm	10	B
86 74 16 05	1x16 cm	10	B
86 74 41 01	2x11 cm	10	B

- 4. Capete rotunjite pe ambele părți**
ambalate individual



4



Lacuri cu conținut de solvenți

Cod art. | Dimensiuni | UV | APG | Descriere

Spumă poliestică, diametru exterior 50 mm structură "superfină"

86 78 16 99	16 cm	10	B		1. Capete rotunjite pe ambele părți ambalate individual	TOP QUALITY	Extra fine finish		1

Lacuri cu conținut de solvenți

Lână (Velur), țesut

86 50 10 10	1x10 cm	10	B		2. Lungime fir: 4 mm g/m ² min.: 770 ambalate individual	TOP QUALITY	Extra fine finish		2
86 50 15 27	1x15 cm	10	B		ambalate individual blister				
86 50 30 99	2x6 cm	10	B		Pachet 2 buc				
86 50 70 01	2x10 cm	10	B						
86 50 40 99	10x10 cm	1	B	com.specială	Pachet 10 buc				
86 50 80 99	20x6 cm	1	B	com.specială	Pachet 20 buc				

Lacuri cu conținut de solvenți

Poliester, țesut

86 60 10 10	10 cm	10	B		3. Lungime fir: 4 mm g/m ² min.: 550 fir continuu scămoșat, stabilizat, ideal pentru lacuri acrilice pe bază de apă și lacuri pe bază de ulei, ambalat individual	PROFI QUALITY		3

Lacuri pe bază de apă/ acrilice

Poliacril, țesut

86 41 10 10	10 cm	10	B	com.specială	4. Lungime fir: 8 mm, g/m ² : min. 700	PROFI QUALITY		4

Lacuri pe bază de apă/ acrilice

Poliamid, țesut

86 35 10 10	10 cm	10	B		5. Lungime fir: 7 mm g/m ² min.: 640 fir continuu stabilizat blister, ideal pentru sigilări parchet, ambalat individual, blister	TOP QUALITY	Extra lint free		5

Lacuri pe bază de apă/ acrilice

Spumă poliestică plușată, diametru exterior 35 mm

86 76 07 05	7 cm	10	B		6. Capete rotunjite, ambalat individual, blister	TOP QUALITY	Extra fine finish		6
86 76 11 05	11 cm	10	B						
86 76 16 05	16 cm	10	B						

Lacuri pe bază de apă/ acrilice

Miez 30 mm, lipit

Velur, țesut

86 51 10 10	10 cm	10	B	
-------------	-------	----	---	--

1. Lungime fir: 4 mm,
g/m²: min. 730.

TOP
QUALITY



1



Lacuri cu conținut de solvenți

Role (cu lungimea firului de peste 8 mm)

Diametru miez 15/ 16 mm

Microfibră

86 52 11 10	1x10 cm	10	B	com.specială
86 52 10 01	2x10 cm	10	B	

2. Lungime fir: 9 mm
g/m² min.: 675
fir continuu fixat,
ambalat individual

blister 2 buc

TOP
QUALITY



2



Baițuri/ protecție lemn

Poliester, țesut

86 40 11 10	10 cm	10	B	com.specială
-------------	-------	----	---	--------------

3. Lungime fir: 13 mm
g/m² min.: 820
ambalat individual

BASIS
QUALITY

3



Vopsele în dispersie, pe bază de latex și pt. fațade

Poliacril, țesut

86 37 10 10	1x10 cm	10	B	
86 37 15 99	2x6 cm	10	B	
86 37 40 01	2x10 cm	10	B	
86 37 41 99	10x10 cm	1	B	com.specială

4. Lungime fir: 12 mm
g/m² min.: 720
ambalat individual

blister 2 buc

Pachet 10 buc

PROFI
QUALITY



4



Vopsele în dispersie, pe bază de latex și pt. fațade

Microfibră, țesut

86 58 10 10	1x10 cm	10	B	com.specială
-------------	---------	----	---	--------------

5. Lungime fir: 15 mm
g/m² min.: 1000
cusut
Ideal pentru grunduri și
impregnări
ambalat individual

TOP
QUALITY



5



Vopsele în dispersie, pe bază de latex și pt. fațade

Poliamid, țesut

Cod art.	Dimensiuni	UV	APG	Descriere	TOP QUALITY	Extra long life	max	1
86 31 10 10	1x10 cm	10	B	1. Lungime fir: 12 mm g/m ² min.: 860 ambalat individual	TOP QUALITY	Extra long life	max	
86 31 15 05	1x15 cm	10	B	ambalat individual, blister				
86 31 40 01	2x10 cm	10	B	blister 2 buc				

Vopsele în dispersie, pe bază de latex și pt. fațade

Cod art.	Dimensiuni	UV	APG	Descriere	TOP QUALITY	Extra long life	Extra lint free	2
86 33 09 10	1x10 cm	10	B	2. Lungime fir: 13 mm g/m ² min.: 900 ideal pentru vopsele epoxidice, acoperiri din două componente, sigilări ambalat individual	TOP QUALITY	Extra long life	Extra lint free	
86 33 15 99	1x15 cm	10	B	com.specială ambalat individual blister				
86 33 40 01	2x10 cm	10	B	blister 2 buc				

Vopsele în dispersie, pe bază de latex și pt. fațade

Cod art.	Dimensiuni	UV	APG	Descriere	TOP QUALITY	Extra long life	Extra high capacity	Extra easy cleaning	3
86 28 10 10	1x10 cm	10	B	3. Lungime fir: 13 mm g/m ² min.: 940 fir continuu, prelucrat fără scame ambalat individual	TOP QUALITY	Extra long life	Extra high capacity	Extra easy cleaning	

Vopsele în dispersie, pe bază de latex și pt. fațade

Miez 30 mm, lipit

Poliamid, țesut

Cod art.	Dimensiuni	UV	APG	Descriere	TOP QUALITY	Extra lint free	4
86 35 50 01	10 cm	10	B	com.specială 4. Lungime fir: 7 mm g/m ² min.: 640 fără fir continuu, stabilizat, ideal pentru sigilări parchet ambalat individual, blister	TOP QUALITY	Extra lint free	

Lacuri pe bază de apă/ acrilice

Microfibră, țesut

86 52 30 05	1x10 cm	10	B	
-------------	---------	----	---	--

1. Lungime fir: 9 mm
g/m² min.: 675
fir continuu, fixat
ambalat individual, blister



1



Baițuri/ protecție lemn

Poliacril, țesut

86 36 10 05	1x10 cm	10	B	
86 36 40 99	10x10 cm	1	B	com.specială

2. Lungime fir: 12 mm
g/m² min.: 720
ambalat individual blister



2

Pachet 10 buc



Vopsele în dispersie, pe bază de latex și pt. fațade

Poliamid, țesut

86 32 15 01	15 cm	10	B	com.specială
-------------	-------	----	---	--------------

3. Lungime fir: 12 mm
g/m² min.: 860
ambalat individual, blister



3



Vopsele în dispersie, pe bază de latex și pt. fațade

Trafaletți pentru suprafețe mici și seturi

Spumă poliesterică, structură "fină"

86 96 05 20	5 cm	10	B	
86 84 11 20	11 cm	10	B	

4. Rolă: margini drepte
etrier 19 cm



4

5

5. Rolă: margini drepte
etrier 29 cm



Lacuri cu conținut de solvenți

Cod art.	Dimensiuni	UV	APG	Descriere
86 91 05 20	5 cm	10	C	1. Set cu 3 comp: Rolă: margini drepte, etrier 19 cm Tăviță: 12x23 cm.
86 90 11 20	11 cm	10	C	

BASIS

QUALITY

1

2



Lacuri cu conținut de solvenți

86 93 30 20	10 cm	10	B	3. Set cu 3 componente: Rolă: velur 30mm, etrier 29 cm Tăviță: 15x32 cm
86 94 11 05		10	C	

PROFI

QUALITY

3

4



Lacuri cu conținut de solvenți

Spumă poliestică, structură "superfină"

86 97 16 05	16 cm	5	B	5. capete rotunjite pe ambele părți exterior \varnothing 50 mm cu etrier detașabil: 6mm

TOP

QUALITY

Extra high capacity



Extra fine finish



5



Lacuri cu conținut de solvenți

Spumă poliestică, plușată

86 76 29 99	11 cm	10	B	6. capete rotunjite pe ambele părți Mâner: 29 cm
86 92 11 99	11 cm	10	C	

TOP

QUALITY

Extra fine finish



6

7



Lacuri pe bază de apă/ acrilice

Microfibră, țesut

86 52 50 05	10 cm	10	B	
86 52 70 05	10 cm	10	B	

1. Lungime fir: 9 mm
g/m² min: 675
Miez 16 mm
Mâner: 29 cm
2. Set cu 3 comp:
Lungime fir: 9 mm
g/m² min: 675
Miez 16 mm
Mâner: 29 cm
Tăviță: 15 x 32 cm



1

2



Baițuri/ protecție lemn

Poliacril

86 98 10 99	10 cm	10	B	
86 98 39 99	10 cm	5	B	com.specială
86 98 40 05	10 cm	10	C	

3. Lungime fir: 12 mm
g/m² min: 720
Miez 15 mm
Mâner: 29 cm
4. Lungime fir: 12 mm
g/m² min: 720
Miez 30 mm
Mâner: 39 cm
5. Set cu 3 comp:
Lungime fir: 12 mm
g/m² min: 700
Miez 15 mm
Mâner: 29 cm
Tăviță: 15 x 32 cm.



3

4

5



Vopsele în dispersie, pe bază de latex și pt. fațade

Dispozitive pentru utilizări speciale

84 84 11 20	115x80 mm	I	B	com.specială
84 84 12 44	115x80 mm	I	B	com.specială
86 83 11 01	10 cm	I	B	com.specială
86 80 39 27		5	B	
86 80 40 27		5	B	
86 82 99 01		I	B	com.specială
86 82 10 99		I	B	com.specială

6. Dispozitiv pentru vopsit canturi
D/NL/F/I
Fără fig:
rezervă pentru dispozitivul de vopsit canturi
D/NL/F/I
7. Trafalet tăiat poliamid,
lungime fir 12 mm
8. Trafalet colțuri
Poliacril
Lungime fir: 12 mm
Mâner: 39 cm.

Fără fig:
Rezervă pentru trafalet colțuri.
9. Trafalet vopsit țevi
Poliamid
Mâner: 39 mm

Fără fig:
Rola de schimb pt. trafalet vopsit țevi



6

7

8

9



Vopsele în dispersie, pe bază de latex și pt. fațade

Trafaleți structură, pentru mâner de 8mm

86 71 25 20	25 cm	5	B	com.specială

1. Structură grosieră
Ø 75 mm



1

Rolă structurată, etrier fix 6 mm

85 88 19 27	18 cm	I	B	
85 89 19 27	18 cm	I	B	

2. Structură grosieră
Ø 75 mm

3. "Bob de mazăre"
Ø 75 mm



2



3

Rolă cu țepi, miez 45 mm, etrier fix 8 mm

86 94 24 99	24 cm	I	B	
-------------	-------	---	---	--

4. Cu țepi din plastic
de 11 mm,
ideal pentru nivelarea
materialelor cu viscozitate
ridicată
(mase de nivelare, șape)



4

**Mânere pentru trafaleți
pentru role pt. suprafețe mari
și role pt. suprafețe mici**

Variante
de mâner



b

c

d

e

f

Pentru role pt. suprafețe mari cu lățimea rolei: 18 – 27cm, etrier de 8 mm

84 00 18 99	18 cm	10	C	
84 00 25 99	25 cm	10	C	
84 07 18 99	18 cm	10	C	com.specială
84 07 25 99	25 cm	10	C	com.specială

5. Varianta de mâner: b
tijă telescopică

6. Varianta de mâner: d
Mâner Komfort cu
întăritură pentru folosire
înelungată,
tijă telescopică



5



6

84 05 07 10	18 cm	10	C	com.specială
84 05 10 10	25 cm	10	C	com.specială
84 05 18 10	18 cm	10	C	
84 05 25 10	25 cm	10	C	

7. Varianta de mâner: f
Mâner cu 2 componente

8. Varianta de mâner: e
Mâner cu 2 componente
pentru folosire
înelungată,
tijă telescopică



7



8

Mâner special



85 05 45 10	32-58 cm	I	C	com.specială	<p>1. Etrier Jumbo pentru role foarte late Varianta de mâner: b</p>		1
-------------	----------	---	---	--------------	--	--	---

Pentru role pt. suprafețe mici cu lățimea rolei: 5 – 16 cm, etrier de 6mm



86 00 19 99	19 cm „b”	10	C		<p>2. Varianta de mâner: b,c Pentru lățime rolă 5-7 cm</p>	2	3	4	5	6
86 01 19 10	19 cm „c”	10	C							
86 00 29 99	29 cm „b”	10	C		<p>3. Varianta de mâner: b,c Pentru lățime rolă 10-16 cm.</p>					
86 01 29 10	29 cm „c”	10	C							
86 00 39 99	39 cm „b”	10	C		<p>4. Varianta de mâner: b,c Pentru lățime rolă 10-16 cm</p>					
86 01 39 10	39 cm „c”	10	C							
86 04 39 10	39 cm „e”	10	C	com.specială	<p>5. Varianta de mâner: e Pentru lățime rolă 10-16 cm.</p>					
86 00 56 99	56 cm „b”	10	C	com.specială						
					<p>6. Varianta de mâner: b Pentru lățime rolă 10-16 cm</p>					

Alte accesorii pentru vopsire

Recipienți

84 83 80 10		10	A	com.specială	<p>7. Recipient pensule cu capac. Capacitate: 700 ml</p>	7	8
84 83 50 27		20	B				
					<p>8. Expert Cup Vas cu mâner pentru curățat role mici și pensule. Capacitate: 2 litri</p>		

Grătare

84 83 40 10	18x20 cm	10	C		<p>9. Plastic.</p>	9	10
84 83 29 10	21x25 cm	10	C				
84 83 28 10	26x28 cm	10	C				
84 83 27 10	26x30 cm	10	A		<p>10. Metal (zincat)</p>		

Cod art. | Dimensiuni | UV | APG | Descriere

Tăvițe vopsea

84 80 11 05	15x32 cm	10	C	
84 80 12 05	20x22 cm	10	C	
84 80 18 05	26x32 cm	10	C	
84 80 25 05	32x36 cm	10	C	
84 80 30 10	30x47 cm	15	C	

1. Tăvițe vopsea,
Plastic

2. Tăviță vopsea,
Plastic, perete gros

**Găleță vopsea, suport magnetic instrumente**

84 82 08 10	8 l	I	C	
84 82 14 10	12 l	I	C	
84 82 44 10	14 l	I	C	com.specială
84 89 10 37		20	B	

3. Găleată vopsea,
plastic,
dreptunghiulară cu
perete lateral renurată

4. Suport magnetic instrumente
cu deschizător de cutii.
Se poate fixa pe cutii de
vopsea, găleți și pe vasul
Expert Cup.

**Tije de prelungire, reglabile telescopic****Oțel**

84 90 13 20	130 cm	10	B	
84 90 20 20	200 cm	10	B	
84 90 30 20	300 cm	10	B	

5. Tija telescopică
reglabilă la alegere
diametru exterior
25 mm

**Aluminiu**

84 92 00 27	200 cm	6	B	
84 93 00 01	300 cm	6	B	

6. Tija telescopică,
cu clemă de prindere pt
mâner



84 96 22 95	220 cm	I	B	com.specială
-------------	--------	---	---	--------------

7. Tija telescopică,
cu clemă de prindere pt
mâner, aluminiu – fibră
de sticlă

**Mixere**

94 30 10 27	10 kg	6	C	
94 30 15 27	15 kg	3	C	
94 30 20 27	20 kg	3	C	

8. Mixer rotund
60 x 400 mm,
Până la 10 kg

85 x 400 mm,
Până la 15 kg

100 x 600 mm,
Până la 20 kg



Pentru alte tipuri de mixere, consultați catalogul: pag 54 și 82